

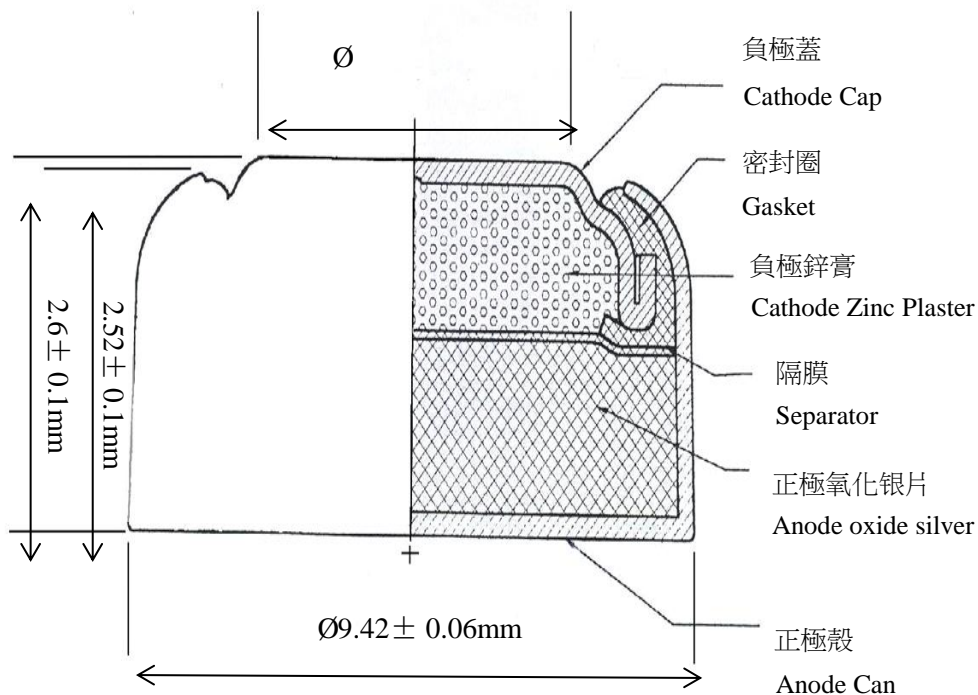

WAMA ELECTRONICS TECHNOLOGY CO.,LTD

SR927SW,395/399,SR57 BUTTON CELL

DIMENSIONS:



NOMINAL VOLTAGE : 1.55 VOLT

APPROX. SERVICE CAPACITY : 46 mAh

APPROX. WEIGHT : 0.63 g

RATED AT 7.5K Ω LOAD TESTED AT 21°C WITHIN 12 MONTHS OF MANUFACTURE.

SYSTEM : ZINC /MANGANESE DIOXIDE.

ESTIMATED AVERAGE HOURS SERVICE AT 21 °C

